

КАТАЛОГ ФИТИНГОВ

Стандартная серия



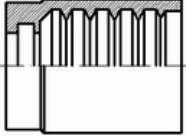
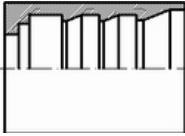
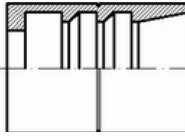
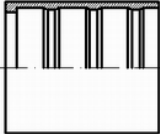
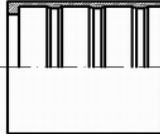
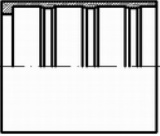
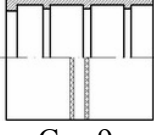

INVERETCOM

СОДЕРЖАНИЕ

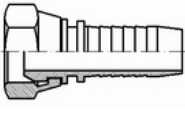
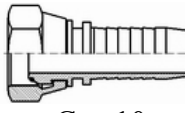
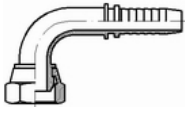
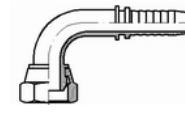
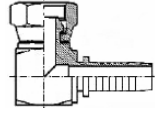
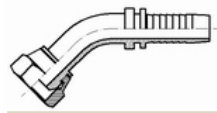
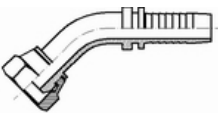
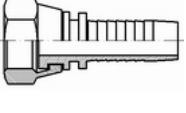
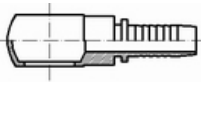

Обжимные муфты

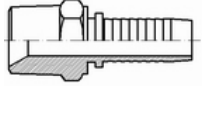
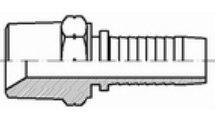
					
Стр.8	Стр.8	Стр.8	Стр.9	Стр.9	Стр.9
R1A/R2A 1SN/2SN	R2A-2ST/DIN 20023 4SP	R1A	Crimp Ferrule for PTFE with Stainless Steel Braid	Crimp Ferrule for PTFE Convuluted Hoses Braid Covered	Crimp Ferrule for SAE R8/R7/Metallic Braid
					
Стр.9					
Муфта Ecology					





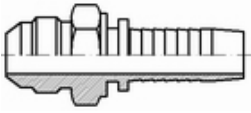

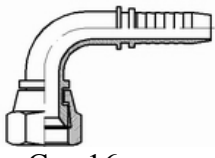
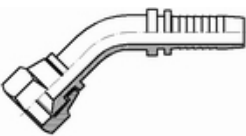
Соединения BSP

					
Стр.10	Стр.10	Стр.11	Стр.11	Стр.11	Стр.12
BSP Swivel Female 60° Cone	BSP Swivel Female 60° Cone with O'ring	90°BSP Swivel Female 60° Cone	90°BSP Swivel Female 60° Cone with O'ring	90° BSP Compact Swivel Female (60° Cone)	45°BSP Swivel Female 60° Cone
					
Стр.12	Стр.12	Стр.13	Стр.13	Стр.14	Стр.14
45°BSP Female Swivel 60° Cone with O'ring	BSP Swivel Female Flat Seat	BSP Banjo (one only piece) Штуцер В- резьбовой (BSP) для болта BS	BSP Male – Cilindrical 60° Cone	BSPT Male Tapered	NPTF Male Фитинг, наружная резьба NPTF, коническое уплотнение 60°
					
Стр.14					
BSP Male Flat Seat					

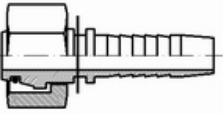
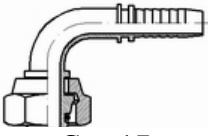
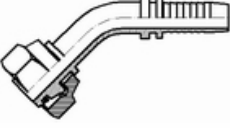
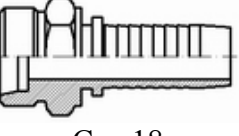
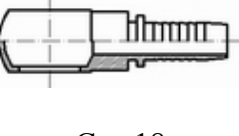
Соединения JIC 74°

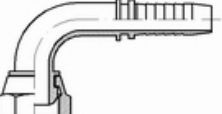
			
Стр.15	Стр.15	Стр.16	Стр.16
Male JIC 74° Cone UNF-UN Фитинг JIC, унифицированная наружная резьба, коническое уплотнение 74°	JIC Swivel Female 74° Cone Фитинг JIC, поворотный, унифицированная внутренняя резьба, коническое уплотнение 74°	90° JIC Swivel Female 74° Cone Фитинг JIC, унифицированная внутренняя резьба, угловой 90°, коническое уплотнение 74° Обжимная гайка	45° JIC Swivel Female 74° Cone Фитинг JIC, унифицированная внутренняя резьба, угловой 45°, коническое уплотнение 74° Обжимная гайка

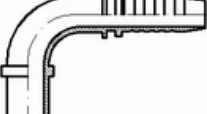
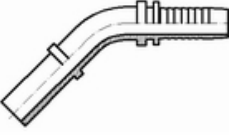
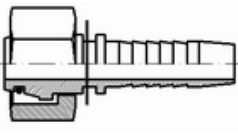
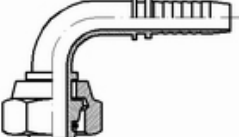
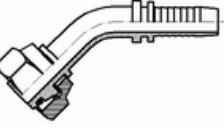
Соединения метрические DIN 2353 DKOR

 <p>Стр.17</p>	 <p>Стр.17</p>	 <p>Стр.18</p>	 <p>Стр.18</p>	 <p>Стр.18</p>
<p>Metric Swivel Female with O'ring 24° Cone Light serie Фитинг прямой, внутренняя М-резьба, коническое уплотнение 24°, с уплотнительным кольцом DKOL</p>	<p>90°Metric Swivel Female with O'ring 24° Cone with Crimped Nut DKO Light serie Фитинг угловой 90°, внутренняя М-резьба, коническое уплотнение 24°, с уплотнительным кольцом Накидная гайка DKOL</p>	<p>45°Metric Swivel Female with O'ring 24° Cone with Crimped Nut DKO Light serie Фитинг угловой 45°, внутренняя М-резьба, коническое уплотнение 24°, с уплотнительным кольцом Накидная гайка DKOL</p>	<p>Metric Stud 24° Cone Light serie Фитинг прямой, наружная М-резьба, низкое давление, коническое уплотнение 24° Накидная гайка</p>	<p>Banjo Metric(one only piece) Банджо для болта, М-резьба</p>
 <p>Стр.19</p>	 <p>Стр.19</p>	 <p>Стр.19</p>	 <p>Стр.20</p>	 <p>Стр.120</p>
<p>Metric Swivel Female 24°/60° Cone DKL</p>	<p>90°Metric Swivel Female 24°/60° Cone DKL</p>	<p>45°Metric Swivel Female 24°/60° Cone DKL</p>	<p>Standpipes for DIN 2353 Fittings Штуцер прямой, метрический</p>	<p>90°Standpipes for DIN 2353 Fittings Штуцер угловой 90°, метрический</p>
 <p>Стр.21</p>	 <p>Стр.21</p>	 <p>Стр.21</p>	 <p>Стр.22</p>	 <p>Стр.22</p>
<p>45°Standpipes for DIN 2353 Fittings Штуцер угловой 45°, метрический</p>	<p>Metric Swivel Female with O'ring 24° Cone Heavy serie Фитинг поворотный, прямой, внутренняя М-резьба, коническое уплотнение 24°, с уплотнительным кольцом Накидная гайка</p>	<p>90°Metric Swivel Female with O'ring 24° Cone with Crimped Nut Heavy serie Фитинг поворотный, угловой 90°, внутренняя М-резьба, коническое уплотнение 24°, с уплотнительным кольцом, Накидная гайка DKO</p>	<p>45°Metric Swivel Female with O'ring 24° Cone with Crimped Nut DKO Heavy serie Фитинг поворотный, угловой 45°, внутренняя М-резьба, коническое уплотнение 24°, с уплотнительным кольцом, Накидная гайка</p>	<p>Metric Stud 24° Cone Heavy serie Фитинг прямой, наружная М-резьба MSM, коническое уплотнение 24°</p>



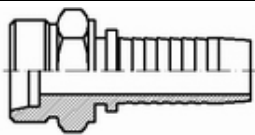
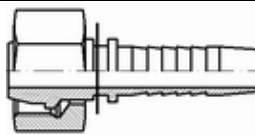
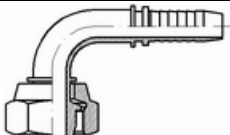
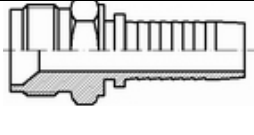

Фитинги метрические(Французская серия)

			
Стр.22	Стр.23	Стр.23	Стр.23
Metric Stud 24° Cone French Serie	Metric Swivel Female 24° Cone French Serie	90°Metric Swivel Female 24° Cone French Serie	Metric Stud for Agricultural Valve

Фитинги метрические(Японская серия)

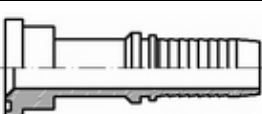
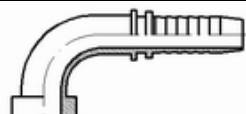
Стр.23
Metric Swivel Female Komatsu Japanese Serie 60° Cone

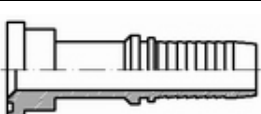
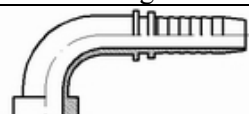
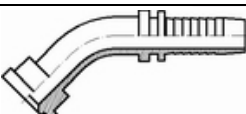
Фланцевые соединения S.A.E. 3000/6000 PSI

			
Стр.24	Стр.24	Стр.24	Стр.25
3000 PSI Straight Flange	3000 PSI 90° Flange	3000 PSI 45° Flange	6000 PSI Straight Flange
			
Стр.25	Стр.25	Стр.25	
6000 PSI 90° Flange	6000 PSI 45° Flange	O'ring for 3000 PSI Flange	

Фланцевые соединения CATERPILLAR

		
Стр.26	Стр.26	Стр.26
CATERPILLAR Фитинг прямой, фланцевый,	CATERPILLAR Фитинг 90°, фланцевый,	CATERPILLAR Фитинг 45°, фланцевый,

Хомут SAE

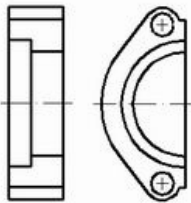
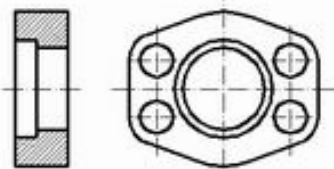
	
Стр.27	Стр.27
SAE Split Flanges 3000/6000 PSI	SAE Flanges 3000/6000 PSI

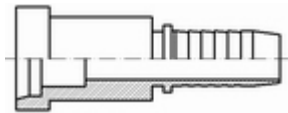
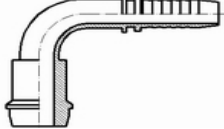

Фланец POCLAIN

		
Стр.28	Стр.28	Стр.28
Poclair Male Flange Standpipe	Poclair Female Flange Standpipe	90° Poclair Female Flange Standpipe

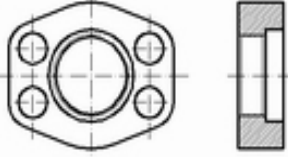
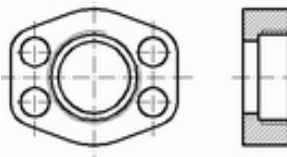
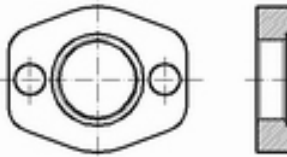
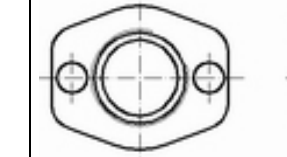

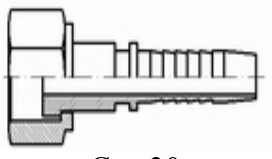
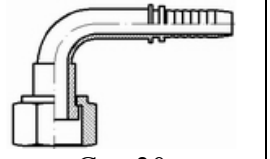
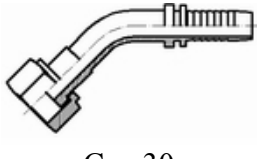

Хомут POCLAIN

			
Стр.29	Стр.29	Стр.29	Стр.29
Male Poclair Flange 4 holes	Female Poclair Flange 4 holes	Male Poclair Flange 2 holes	Female Poclair Flange 2 holes

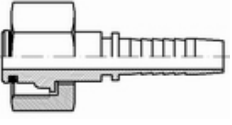
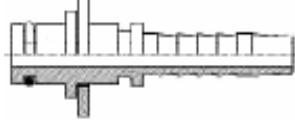

Фитинги ORFS

			
Стр.30	Стр.30	Стр.30	Стр.30
ORFS Caterpillar Straight Swivel Female Flat Seat	90° ORFS Caterpillar Swivel Female Flat Seat	45° ORFS Caterpillar Swivel Female Flat Seat	ORFS Male Flat SEAT O'ring

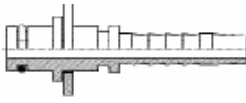
Фитинги для стиральных машин

		
Стр.31	Стр.31	Стр.31
Special brass Ende-Hydrowasher DKSO специальный Для специальной мойки	Male Terminal Steel Hydro-Washing Mashines Специальная мойка Моечный пистолет	Handel with grey rubber
		
Стр.31	Стр.31	Стр.31
Handel with black rubber	Handel with blue rubber	Swivel Female Terminal Steel Hydro-Wash

Фитинги разные

	
Стр.32	Стр.32
Double Crimp Standpipe Рукавный соединитель	Male Stecko Connection STECKO M

Обжимные муфты

Обжимные муфты R1AT/R2AT 1SN/2SN

Кодировка	Характеристики	€
9PF221200300	DN MANGUERA 3/16"	1,03
9PF221200400	DN MANGUERA 1/4"	0,90
9PF221200500	DN MANGUERA 5/16"	1,03
9PF221200600	DN MANGUERA 3/8"	1,07
9PF221200800	DN MANGUERA 1/2"	1,37
9PF221201000	DN MANGUERA 5/8"	1,93
9PF221201200	DN MANGUERA 3/4"	2,66
9PF221201600	DN MANGUERA 1"	4,76
9PF221202000	DN MANGUERA 1"1/4	9,26
9PF221202400	DN MANGUERA 1"1/2	14,10
9PF221203200	DN MANGUERA 2"	22,50

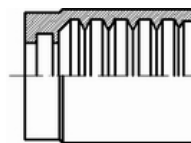

Обжимные муфты R2A-2ST/DIN 20023 4SP

Кодировка	Характеристики	€
9PF122400300	DN MANGUERA 3/16"	1,29
9PF122400400	DN MANGUERA 1/4"	0,86
9PF122400500	DN MANGUERA 5/16"	1,03
9PF122400600	DN MANGUERA 3/8"	1,11
9PF122400800	DN MANGUERA 1/2"	1,46
9PF122401000	DN MANGUERA 5/8"	2,10
9PF122401200	DN MANGUERA 3/4"	2,87
9PF122401600	DN MANGUERA 1"	4,84
9PF122402000	DN MANGUERA 1"1/4	9,39
9PF122402400	DN MANGUERA 1"1/2	14,10
9PF122403200	DN MANGUERA 2"	22,41

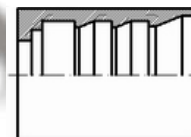

Обжимные муфты R1A

Кодировка	Характеристики	€
9220030300	DN MANGUERA 3/16"	1,22
9220030400	DN MANGUERA 1/4"	0,86
9220030500	DN MANGUERA 5/16"	0,94
9220030600	DN MANGUERA 3/8"	1,03
9220030800	DN MANGUERA 1/2"	1,41
9220031000	DN MANGUERA 5/8"	1,97
9220031200	DN MANGUERA 3/4"	2,61
9220031600	DN MANGUERA 1"	4,33
9220032000	DN MANGUERA 1"1/4	8,44
9220032400	DN MANGUERA 1"1/2	9,81
9220033200	DN MANGUERA 2"	22,29

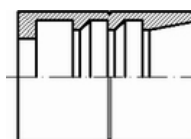

Crimp Ferrule for PTFE with Stainless Steel Braid

Кодировка	Характеристики	€
9210400300	DN MANGUERA 3/16"	1,14
9210400400	DN MANGUERA 1/4"	1,31
9210400500	DN MANGUERA 5/16"	1,42
9210400600	DN MANGUERA 3/8"	1,53
9210400800	DN MANGUERA 1/2"	1,61
9210401000	DN MANGUERA 5/8"	2,28
9210401200	DN MANGUERA 3/4"	2,89
9210401600	DN MANGUERA 1"	4,94

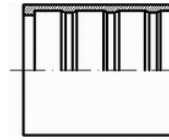

Crimp Ferrule for PTFE Convuluted Hoses Braid Covered

Кодировка	Характеристики	€
9210410400	DN MANGUERA 1/4"	1,51
9210410600	DN MANGUERA 3/8"	1,63
9210410800	DN MANGUERA 1/2"	1,76
9210411000	DN MANGUERA 5/8"	2,06
9210411200	DN MANGUERA 3/4"	2,63
9210411600	DN MANGUERA 1"	5,67
9210412000	DN MANGUERA 1"1/4	10,99
9210412400	DN MANGUERA 1"1/2	12,02
9210413200	DN MANGUERA 2"	17,61
9210414000	DN MANGUERA 2"1/2	26,98

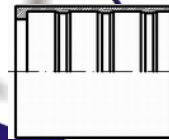

Crimp Ferrule for SAE R8/R7/Metallic Braid

Кодировка	Характеристики	€
9PF2300300	DN MANGUERA 3/16"	0,94
9210120200	DN MANGUERA 1/8"	0,99
9PF2300400	DN MANGUERA 1/4"	0,94
9PF2300500	DN MANGUERA 5/16"	1,03
9PF2300600	DN MANGUERA 3/8"	1,29
9PF2300800	DN MANGUERA 1/2"	1,46
9210121000	DN MANGUERA 5/8"	2,49
9210121200	DN MANGUERA 3/4"	2,59
9210121600	DN MANGUERA 1"	5,04

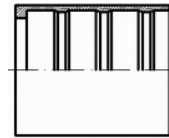

Муфта Ecology

Кодировка	Характеристики	€
9212001200	DN MANGUERA 3/4"	8,01

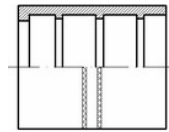

ФИТИНГИ

Соединения BSP

BSP Swivel Female 60° Cone		
Кодировка	Характеристики	€
9241000202	DN MANGUERA 1/8"; ROSCA 1/8" BSP	2,10
9241000203	DN MANGUERA 3/16"; ROSCA 1/8" BSP	1,98
9241000204	DN MANGUERA 1/4"; ROSCA 1/8" BSP	1,65
9241000403	DN MANGUERA 3/16"; ROSCA 1/4" BS	1,71
9241000404	DN MANGUERA 1/4"; ROSCA 1/4" BSP	1,03
9241000405	DN MANGUERA 5/16"; ROSCA 1/4" BSP	1,71
9241000406	DN MANGUERA 3/8"; ROSCA 1/4" BSP	2,70
9241000604	DN MANGUERA 1/4"; ROSCA 3/8" BSP	1,51
9241000605	DN MANGUERA 5/16"; ROSCA 3/8" BSP	1,44
9241000606	DN MANGUERA 3/8"; ROSCA 3/8" BSP	1,25
9241000608	DN MANGUERA 1/2"; ROSCA 3/8" BSP	2,55
9241000804	DN MANGUERA 1/4"; ROSCA 1/2" BSP	2,61
9241000806	DN MANGUERA 3/8"; ROSCA 1/2" BSP	2,06
9241000808	DN MANGUERA 1/2"; ROSCA 1/2" BSP	1,89
9241000810	DN MANGUERA 5/8"; ROSCA 1/2" BSP	4,65
9241001008	DN MANGUERA 1/2"; ROSCA 5/8" BSP	3,55
9241001010	DN MANGUERA 5/8"; ROSCA 5/8" BSP	3,51
9241001208	DN MANGUERA 1/2"; ROSCA 3/4" BSP	4,41
9241001210	DN MANGUERA 5/8"; ROSCA 3/4" BSP	3,34
9241001212	DN MANGUERA 3/4"; ROSCA 3/4" BSP	3,49
9241001612	DN MANGUERA 3/4"; ROSCA 1" BSP	7,80
9241001616	DN MANGUERA 1"; ROSCA 1" BSP	6,17



BSP Swivel Female 60° Cone with O'ring		
Кодировка	Характеристики	€
9241100404	N MANGUERA 1/4"; ROSCA 1/4" BS	1,71
9241100606	DN MANGUERA 3/8"; ROSCA 3/8" BSP	2,28
9241100808	DN MANGUERA 1/2"; ROSCA 1/2" BSP	2,70
9241101010	DN MANGUERA 5/8"; ROSCA 5/8" BSP	9,77
9241101210	DN MANGUERA 5/8"; ROSCA 3/4" BSP	5,96
9241101212	DN MANGUERA 3/4"; ROSCA 3/4" BSP	4,84
9241101616	DN MANGUERA 1"; ROSCA 1" BSP	8,66
9241102016	DN MANGUERA 1"; ROSCA 1"1/4 BSP	16,84
9241102020	DN MANGUERA 1"1/4; ROSCA 1"1/4 BSP	14,49
9241102420	DN MANGUERA 1"1/4; ROSCA 1"1/2 BSP	25,54
9241102424	DN MANGUERA 1"1/2; ROSCA 1"1/2 BSP	24,81
9241103224	DN MANGUERA 1"1/2; ROSCA 2" BSP	42,64
9241103232	DN MANGUERA 2"; ROSCA 2" BSP	39,69



90°BSP Swivel Female 60° Cone		
Кодировка	Характеристики	€
9241070203	DN MANGUERA 3/16"; ROSCA 1/8" BSP	4,08
9241070204	DN MANGUERA 1/4"; ROSCA 1/8" BSP	4,05
9241070403	DN MANGUERA 3/16"; ROSCA 1/4" BSP	4,08
9241070404	DN MANGUERA 1/4"; ROSCA 1/4" BSP	1,91
9241070604	DN MANGUERA 1/4"; ROSCA 3/8" BSP	2,96
9241070605	DN MANGUERA 5/16"; ROSCA 3/8" BSP	2,79
9241070606	DN MANGUERA 3/8"; ROSCA 3/8" BSP	2,49
9241070804	DN MANGUERA 1/4"; ROSCA 1/2" BSP	9,64
9241070806	DN MANGUERA 3/8"; ROSCA 1/2" BSP	3,73
9241070808	DN MANGUERA 1/2"; ROSCA 1/2" BSP	3,26
9241071008	DN MANGUERA 1/2"; ROSCA 5/8" BSP	6,36
9241071010	DN MANGUERA 5/8"; ROSCA 5/8" BSP	6,90
9241071208	DN MANGUERA 1/2"; ROSCA 3/4" BSP	11,83
9241071210	DN MANGUERA 5/8"; ROSCA 3/4" BSP	7,50
9241071212	DN MANGUERA 3/4"; ROSCA 3/4" BSP	6,57
9241071612	DN MANGUERA 3/4"; ROSCA 1" BSP	13,84
9241071616	DN MANGUERA 1"; ROSCA 1" BSP	15,43

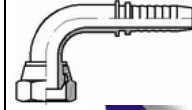

90°BSP Swivel Female 60° Cone with O'ring		
Кодировка	Характеристики	€
9241170404	DN MANGUERA 1/4"; ROSCA 1/4" BSP	3,21
9241170606	DN MANGUERA 3/8"; ROSCA 3/8" BSP	3,73
9241170808	DN MANGUERA 1/2"; ROSCA 1/2" BSP	4,97
9241171010	DN MANGUERA 5/8"; ROSCA 5/8" BSP	21,30
9241171212	DN MANGUERA 3/4"; ROSCA 3/4" BSP	10,59
9241171616	DN MANGUERA 1"; ROSCA 1" BSP	18,21
9241172016	DN MANGUERA 1"; ROSCA 1"1/4 BSP	35,27
9241172020	DN MANGUERA 1"1/4; ROSCA 1"1/4 BSP	32,70
9241172420	DN MANGUERA 1"1/4; ROSCA 1"1/2 BSP	51,64
9241172424	DN MANGUERA 1"1/2; ROSCA 1"1/2 BSP	45,94
9241173232	DN MANGUERA 2"; ROSCA 2" BSP	83,44

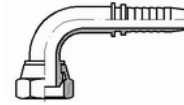

90° BSP Compact Swivel Female (60° Cone)		
Кодировка	Характеристики	€
9241270404	DN MANGUERA 1/4"; ROSCA 1/4" BSP	3,67
9241270606	DN MANGUERA 3/8"; ROSCA 3/8" BSP	4,29
9241270808	DN MANGUERA 1/2"; ROSCA 1/2" BSP	6,60
9241271212	DN MANGUERA 3/4"; ROSCA 3/4" BSP	13,08

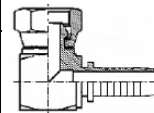

45°BSP Swivel Female 60° Cone

Кодировка	Характеристики	€
9241080203	DN MANGUERA 3/16"; ROSCA 1/8" BSP	4,55
9241080204	DN MANGUERA 1/4"; ROSCA 1/8" BSP	4,88
9241080403	DN MANGUERA 3/16"; ROSCA 1/4" BSP	4,88
9241080404	DN MANGUERA 1/4"; ROSCA 1/4" BSP	2,31
9241080604	DN MANGUERA 1/4"; ROSCA 3/8" BSP	3,49
9241080605	DN MANGUERA 5/16"; ROSCA 3/8" BSP	3,69
9241080606	DN MANGUERA 3/8"; ROSCA 3/8" BSP	2,87
9241080806	DN MANGUERA 3/8"; ROSCA 1/2" BSP	4,11
9241080808	DN MANGUERA 1/2"; ROSCA 1/2" BSP	4,11
9241081008	DN MANGUERA 1/2"; ROSCA 5/8" BSP	9,00
9241081010	DN MANGUERA 5/8"; ROSCA 5/8" BSP	6,60
9241081210	DN MANGUERA 5/8"; ROSCA 3/4" BSP	11,10
9241081212	DN MANGUERA 3/4"; ROSCA 3/4" BSP	7,74
9241081612	DN MANGUERA 3/4"; ROSCA 1" BSP	14,61
9241081616	DN MANGUERA 1"; ROSCA 1" BSP	15,43

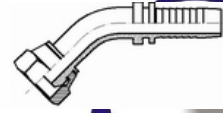

45°BSP Female Swivel 60° Cone with O'ring

Кодировка	Характеристики	€
9241180404	DN MANGUERA 1/4"; ROSCA 1/4" BSP	3,26
9241180606	DN MANGUERA 3/8"; ROSCA 3/8" BSP	4,07
9241180808	DN MANGUERA 1/2"; ROSCA 1/2" BSP	5,06
9241181010	DN MANGUERA 5/8"; ROSCA 5/8" BSP	21,69
9241181210	DN MANGUERA 5/8"; ROSCA 3/4" BSP	8,27
9241181212	DN MANGUERA 3/4"; ROSCA 3/4" BSP	11,57
9241181616	DN MANGUERA 1"; ROSCA 1" BSP	18,30
9241182016	DN MANGUERA 1"; ROSCA 1"1/4 BSP	35,27
9241182020	DN MANGUERA 1"1/4; ROSCA 1"1/4 BSP	32,70
9241182420	DN MANGUERA 1"1/4; ROSCA 1"1/2 BSP	59,14
9241182424	DN MANGUERA 1"1/2; ROSCA 1"1/2 BSP	47,96
9241183224	DN MANGUERA 1"1/2; ROSCA 2" BSP	98,49
9241183232	DN MANGUERA 2"; ROSCA 2" BSP	81,60

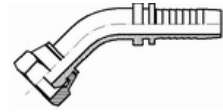

BSP Swivel Female Flat Seat

Кодировка	Характеристики	€
9242000404	DN MANGUERA 1/4"; ROSCA 1/4" BSP	2,16
9242000605	DN MANGUERA 5/16"; ROSCA 3/8" BSP	2,16
9242000606	DN MANGUERA 3/8"; ROSCA 3/8" BSP	2,16
9242000806	DN MANGUERA 3/8"; ROSCA 1/2" BSP	2,81
9242000808	DN MANGUERA 1/2"; ROSCA 1/2" BSP	2,81
9242001208	DN MANGUERA 1/2"; ROSCA 3/4" BSP	5,62
9242001212	DN MANGUERA 3/4"; ROSCA 3/4" BSP	5,62
9242001616	DN MANGUERA 1"; ROSCA 1" BSP	9,64



BSP Banjo (one only piece)

Кодировка	Характеристики	€
9241110403	DN MANGUERA 3/16"; ORIENTABLE 1/4" BSP	3,60
9241110404	DN MANGUERA 1/4"; ORIENTABLE 1/4" BSP	1,99
9241110405	DN MANGUERA 1/4"; ROSCA 5/16" BSP	2,45
9241110406	DN MANGUERA 3/8"; ORIENTABLE 1/4" BSP	3,14
9241110604	DN MANGUERA 1/4"; ORIENTABLE 3/8" BSP	2,46
9241110605	DN MANGUERA 5/16"; ORIENTABLE 3/8" BSP	3,20
9241110606	DN MANGUERA 3/8"; ORIENTABLE 3/8" BSP	2,19
9241110608	DN MANGUERA 1/2"; ORIENTABLE 3/8" BSP	4,10
9241110806	DN MANGUERA 3/8"; ORIENTABLE 1/2" BSP	3,73
9241110808	DN MANGUERA 1/2"; ORIENTABLE 1/2" BSP	17,36
9241111010	DN MANGUERA 5/8"; ORIENTABLE 5/8" BSP	24,88
9241111208	DN MANGUERA 1/2"; ORIENTABLE 3/4" BSP	9,95
9241111212	DN MANGUERA 3/4"; ORIENTABLE 3/4" BSP	28,20
9241111616	DN MANGUERA 1"; ORIENTABLE 1" BSP	

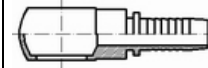

BSP Male – Cilindrical 60° Cone

Кодировка	Характеристики	€
9241120203	DN MANGUERA 3/16"; ROSCA 1/8" BSP	2,16
9241120204	DN MANGUERA 1/4"; ROSCA 1/8" BSP	1,77
9241120402	DN MANGUERA 1/8"; ROSCA 1/4" BSP	3,51
9241120403	DN MANGUERA 3/16"; ROSCA 1/4" BSP	3,09
9241120404	DN MANGUERA 1/4"; ROSCA 1/4" BSP	1,32
9241120406	DN MANGUERA 3/8"; ROSCA 1/4" BSP	3,10
9241120604	DN MANGUERA 1/4"; ROSCA 3/8" BSP	1,86
9241120605	DN MANGUERA 5/16"; ROSCA 3/8" BSP	1,63
9241120606	DN MANGUERA 3/8"; ROSCA 3/8" BSP	1,62
9241120608	DN MANGUERA 1/2"; ROSCA 3/8" BSP	2,93
9241120804	DN MANGUERA 1/4"; ROSCA 1/2" BSP	2,71
9241120806	DN MANGUERA 3/8"; ROSCA 1/2" BSP	2,35
9241120808	DN MANGUERA 1/2"; ROSCA 1/2" BSP	2,26
9241121008	DN MANGUERA 1/2"; ROSCA 5/8" BSP	6,90
9241121010	DN MANGUERA 5/8"; ROSCA 5/8" BSP	4,61
9241121208	DN MANGUERA 1/2"; ROSCA 3/4" BSP	5,53
9241121210	DN MANGUERA 5/8"; ROSCA 3/4" BSP	4,67
9241121212	DN MANGUERA 3/4"; ROSCA 3/4" BSP	4,39
9241121612	DN MANGUERA 3/4"; ROSCA 1" BSP	9,90
9241121616	DN MANGUERA 1"; ROSCA 1" BSP	7,66
9241122016	DN MANGUERA 1"; ROSCA 1"1/4 BSP	21,69
9241122020	DN MANGUERA 1"1/4; ROSCA 1"1/4 BSP	14,70
9241122424	DN MANGUERA 1"1/2; ROSCA 1"1/2 BSP	21,39
9241123232	DN MANGUERA 2"; ROSCA 2" BSP	42,99



BSPT Male Tapered		
Кодировка	Характеристики	€
9241140203	DN MANGUERA 3/16"; ROSCA 1/8" BSPT	2,40
9241140204	DN MANGUERA 1/4"; ROSCA 1/8" BSPT	1,76
9241140404	DN MANGUERA 1/4"; ROSCA 1/4" BSPT	1,84
9241140604	DN MANGUERA 1/4"; ROSCA 3/8" BSPT	3,60
9241140605	DN MANGUERA 5/16"; ROSCA 3/8" BSPT	2,53
9241140606	DN MANGUERA 3/8"; ROSCA 3/8" BSPT	1,97
9241140806	DN MANGUERA 3/8"; ROSCA 1/2" BSPT	2,40
9241140808	DN MANGUERA 1/2"; ROSCA 1/2" BSPT	2,66
9241141210	DN MANGUERA 5/8"; ROSCA 3/4" BSPT	8,40
9241141212	DN MANGUERA 3/4"; ROSCA 3/4" BSPT	4,39
9241141612	DN MANGUERA 3/4"; ROSCA 1" BSPT	10,97
9241141616	DN MANGUERA 1"; ROSCA 1" BSPT	9,73
9241142016	DN MANGUERA 1"; ROSCA 1"1/4 BSPT	19,46
9241142020	DN MANGUERA 1"1/4; ROSCA 1"1/4 BSPT	15,81
9241142424	DN MANGUERA 1"1/2; ROSCA 1"1/2 BSPT	19,11
9241143232	DN MANGUERA 2"; ROSCA 2" BSPT	36,39



NPTF Male		
Кодировка	Характеристики	€
9241610203	DN MANGUERA 3/16"; ROSCA 1/8" NPT	3,70
9241610204	DN MANGUERA 1/4"; ROSCA 1/8" NPT	1,84
9241610404	DN MANGUERA 1/4"; ROSCA 1/4" NPT	1,46
9241610604	DN MANGUERA 1/4"; ROSCA 3/8" NPT	2,45
9241610605	DN MANGUERA 5/16"; ROSCA 3/8" NPT	2,28
9241610606	DN MANGUERA 3/8"; ROSCA 3/8" NPT	2,19
9241610608	DN MANGUERA 1/2"; ROSCA 3/8" NPT	2,91
9241610806	DN MANGUERA 3/8"; ROSCA 1/2" NPT	2,49
9241610808	DN MANGUERA 1/2"; ROSCA 1/2" NPT	2,49
9241610810	DN MANGUERA 5/8"; ROSCA 1/2" NPT	4,37
9241611208	DN MANGUERA 1/2"; ROSCA 3/4" NPT	8,66
9241611212	DN MANGUERA 3/4"; ROSCA 3/4" NPT	3,72
9241611612	DN MANGUERA 3/4"; ROSCA 1" NPT	9,56
9241611616	DN MANGUERA 1"; ROSCA 1" NPT	10,11
9241612016	DN MANGUERA 1"; ROSCA 1"1/4 NPT	16,89
9241612020	DN MANGUERA 1"1/4; ROSCA 1"1/4 NPT	14,53
9241612424	DN MANGUERA 1"1/2; ROSCA 1"1/2 NPT	19,11
9241613232	DN MANGUERA 2"; ROSCA 2" NPT	37,84



BSP Male Flat Seat		
Кодировка	Характеристики	€
9242120404	DN MANGUERA 1/4"; ROSCA 1/4" BSP	2,40
9242120606	DN MANGUERA 3/8"; ROSCA 3/8" BSP	3,56
9242120806	DN MANGUERA 3/8"; ROSCA 1/2" BSP	3,77
9242120808	DN MANGUERA 1/2"; ROSCA 1/2" BSP	4,16
9242121212	DN MANGUERA 3/4"; ROSCA 3/4" BSP	8,66



Соединения JIC 74°

Male JIC 74° Cone UNF-UN		
Кодировка	Характеристики	€
9241400703	DN MANGUERA 3/16"; ROSCA 7/16" 20h UNF	3,60
9241400704	DN MANGUERA 1/4"; ROSCA 7/16" 20h UNF	1,59
9241400804	DN MANGUERA 1/4"; ROSCA 1/2" 20h UNF	1,71
9241400904	DN MANGUERA 1/4"; ROSCA 9/16" 18h UNF	1,72
9241400905	DN MANGUERA 5/16"; ROSCA 9/16" 18h UNF	1,76
9241400906	DN MANGUERA 3/8"; ROSCA 9/16" 18h UNF	1,50
9241401206	DN MANGUERA 3/8"; ROSCA 3/4" 16h UNF	1,91
9241401208	DN MANGUERA 1/2"; ROSCA 3/4" 16h UNF	2,04
9241401406	DN MANGUERA 3/8"; ROSCA 7/8" 14h UNF	3,21
9241401408	DN MANGUERA 1/2"; ROSCA 7/8" 14h UNF	2,29
9241401410	DN MANGUERA 5/8"; ROSCA 7/8" 14h UNF	3,04
9241401708	DN MANGUERA 1/2"; ROSCA 1"1/16 12h UNF	5,50
9241401710	DN MANGUERA 5/8"; ROSCA 1"1/16 12h UNF	5,01
9241401712	DN MANGUERA 3/4"; ROSCA 1"1/16 12h UNF	5,03
9241402112	DN MANGUERA 3/4"; ROSCA 1"5/16 12h UNF	8,10
9241402116	DN MANGUERA 1"; ROSCA 1"5/16 12h UNF	9,64
9241402616	DN MANGUERA 1"; ROSCA 1"5/8 12h UNF	13,84
9241402620	DN MANGUERA 1"1/4; ROSCA 1"5/8 12h UNF	14,91
9241403020	DN MANGUERA 1"1/4; ROSCA 1"7/8 12h UNF	36,40
9241403024	DN MANGUERA 1"1/2; ROSCA 1"7/8 12h UNF	32,35
9241404032	DN MANGUERA 2"; ROSCA 2"1/2 12h UNF	50,15



JIC Swivel Female 74° Cone		
Кодировка	Характеристики	€
9241420703	DN MANGUERA 3/16"; ROSCA 7/16" 20h UNF	1,83
9241420704	DN MANGUERA 1/4"; ROSCA 7/16" 20h UNF	1,22
9241420804	DN MANGUERA 1/4"; ROSCA 1/2" 20h UNF	1,24
9241420805	DN MANGUERA 5/16"; ROSCA 1/2" 20h UNF	2,28
9241420904	DN MANGUERA 1/4"; ROSCA 9/16" 18h UNF	1,27
9241420905	DN MANGUERA 5/16"; ROSCA 9/16" 18h UNF	1,39
9241420906	DN MANGUERA 3/8"; ROSCA 9/16" 18h UNF	1,42
9241421006	DN MANGUERA 3/8"; ROSCA 5/8" 18h UNF	3,57
9241421205	DN MANGUERA 5/16"; ROSCA 3/4" 16h UNF	4,14
9241421206	DN MANGUERA 3/8"; ROSCA 3/4" 16h UNF	1,68
9241421208	DN MANGUERA 1/2"; ROSCA 3/4" 16h UNF	1,82
9241421406	DN MANGUERA 3/8"; ROSCA 7/8" 14h UNF	4,59
9241421408	DN MANGUERA 1/2"; ROSCA 7/8" 14h UNF	2,07
9241421410	DN MANGUERA 5/8"; ROSCA 7/8" 14h UNF	3,00
9241421708	DN MANGUERA 1/2"; ROSCA 1"1/16 12h UNF	4,95
9241421710	DN MANGUERA 5/8"; ROSCA 1"1/16 12h UNF	3,99
9241421712	DN MANGUERA 3/4"; ROSCA 1"1/16 12h UNF	3,70
9241421716	DN MANGUERA 1"; ROSCA 1"1/16 12h UNF	11,01
9241422112	DN MANGUERA 3/4"; ROSCA 1"5/16 12h UNF	6,20
9241422116	DN MANGUERA 1"; ROSCA 1"5/16 12h UNF	7,37
9241422616	DN MANGUERA 1"; ROSCA 1"5/8 12h UNF	15,81
9241422620	DN MANGUERA 1"1/4; ROSCA 1"5/8 12h UNF	14,87
9241423020	DN MANGUERA 1"1/4; ROSCA 1"7/8 12h UNF	27,77
9241423024	DN MANGUERA 1"1/2; ROSCA 1"7/8 12h UNF	27,39
9241424032	DN MANGUERA 2"; ROSCA 2"1/2 12h UNF	55,50



90°JIC Swivel Female 74° Cone		
Кодировка	Характеристики	€
9241380703	DN MANGUERA 3/16"; ROSCA 7/16" 20h UNF	5,50
9241380704	DN MANGUERA 1/4"; ROSCA 7/16" 20h UNF	2,41
9241380804	DN MANGUERA 1/4"; ROSCA 1/2" 20h UNF	2,55
9241380904	DN MANGUERA 1/4"; ROSCA 9/16" 18h UNF	2,45
9241380905	DN MANGUERA 5/16"; ROSCA 9/16" 18h UNF	3,00
9241380906	DN MANGUERA 3/8"; ROSCA 9/16" 18h UNF	2,91
9241381006	DN MANGUERA 3/8"; ROSCA 5/8" 18h UNF	6,75
9241381206	DN MANGUERA 3/8"; ROSCA 3/4" 16h UNF	3,52
9241381208	DN MANGUERA 1/2"; ROSCA 3/4" 16h UNF	4,07
9241381406	DN MANGUERA 3/8"; ROSCA 7/8" 14h UNF	5,85
9241381408	DN MANGUERA 1/2"; ROSCA 7/8" 14h UNF	4,22
9241381410	DN MANGUERA 5/8"; ROSCA 7/8" 14h UNF	6,40
9241381708	DN MANGUERA 1/2"; ROSCA 1"1/16 12h UNF	13,50
9241381710	DN MANGUERA 5/8"; ROSCA 1"1/16 12h UNF	8,10
9241381712	DN MANGUERA 3/4"; ROSCA 1"1/16 12h UNF	7,90
9241382112	DN MANGUERA 3/4"; ROSCA 1"5/16 12h UNF	14,88
9241382116	DN MANGUERA 1"; ROSCA 1"5/16 12h UNF	14,70
9241382616	DN MANGUERA 1"; ROSCA 1"5/8 12h UNF	31,80
9241382620	DN MANGUERA 1"1/4; ROSCA 1"5/8 12h UNF	27,00
9241383020	DN MANGUERA 1"1/4; ROSCA 1"7/8 12h UNF	54,73
9241383024	DN MANGUERA 1"1/2; ROSCA 1"7/8 12h UNF	49,97
9241384032	DN MANGUERA 2"; ROSCA 2"1/2 12h UNF	130,58

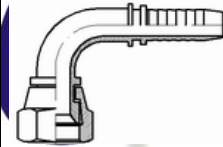

45°JIC Swivel Female 74° Cone		
Кодировка	Характеристики	€
9241391408	DN MANGUERA 1/2"; ROSCA 7/8" 14h UNF	5,14
9241390703	DN MANGUERA 3/16"; ROSCA 7/16" 20h UNF	5,74
9241390704	DN MANGUERA 1/4"; ROSCA 7/16" 20h UNF	3,13
9241390804	DN MANGUERA 1/4"; ROSCA 1/2" 20h UNF	2,82
9241390904	DN MANGUERA 1/4"; ROSCA 9/16" 18h UNF	2,97
9241390905	DN MANGUERA 5/16"; ROSCA 9/16" 18h UNF	3,56
9241390906	DN MANGUERA 3/8"; ROSCA 9/16" 18h UNF	3,30
9241391206	DN MANGUERA 3/8"; ROSCA 3/4" 16h UNF	4,11
9241391208	DN MANGUERA 1/2"; ROSCA 3/4" 16h UNF	4,46
9241391410	DN MANGUERA 5/8"; ROSCA 7/8" 14h UNF	6,39
9241391708	DN MANGUERA 1/2"; ROSCA 1"1/16 12h UNF	11,96
9241391710	DN MANGUERA 5/8"; ROSCA 1"1/16 12h UNF	8,10
9241391712	DN MANGUERA 3/4"; ROSCA 1"1/16 12h UNF	8,40
9241392112	DN MANGUERA 3/4"; ROSCA 1"5/16 12h UNF	15,00
9241392116	DN MANGUERA 1"; ROSCA 1"5/16 12h UNF	15,30
9241392616	DN MANGUERA 1"; ROSCA 1"5/8 12h UNF	29,79
9241392620	DN MANGUERA 1"1/4; ROSCA 1"5/8 12h UNF	29,01
9241393020	DN MANGUERA 1"1/4; ROSCA 1"7/8 12h UNF	58,41
9241393024	DN MANGUERA 1"1/2; ROSCA 1"7/8 12h UNF	55,50
9241394032	DN MANGUERA 2"; ROSCA 2"1/2 12h UNF	130,58

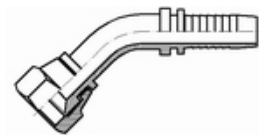

Соединения метрические DIN 2353

Metric Swivel Female with O'ring 24° Cone Light serie		
Кодировка	Характеристики	€
924804120603	DN MANGUERA 3/16"; ROSCA 12X1,5; TUBO 6	2,57
924804120604	DN MANGUERA 1/4"; ROSCA 12X1,5; TUBO 6	1,98
924804140804	DN MANGUERA 1/4"; ROSCA 14X1,5; TUBO 8	1,17
924804161004	DN MANGUERA 1/4"; ROSCA 16X1,5; TUBO 10	1,24
924804161005	DN MANGUERA 5/16"; ROSCA 16X1,5; TUBO 10	1,26
924804161006	DN MANGUERA 3/8"; ROSCA 16X1,5; TUBO 10	1,99
924804181204	DN MANGUERA 1/4"; ROSCA 18X1,5; TUBO 12	1,99
924804181205	DN MANGUERA 5/16"; ROSCA 18X1,5; TUBO 12	1,77
924804181206	DN MANGUERA 3/8"; ROSCA 18X1,5; TUBO 12	1,21
924804221506	DN MANGUERA 3/8"; ROSCA 22X1,5; TUBO 15	2,59
924804221508	DN MANGUERA 1/2"; ROSCA 22X1,5; TUBO 15	1,88
924804261808	DN MANGUERA 1/2"; ROSCA 26X1,5; TUBO 18	4,58
924804261810	DN MANGUERA 5/8"; ROSCA 26X1,5; TUBO 18	2,91
924804302212	DN MANGUERA 3/4"; ROSCA 30X2; TUBO 22	3,75
924804362816	DN MANGUERA 1"; ROSCA 36X2; TUBO 28	6,90
924804453520	N MANGUERA 1" 1/4; ROSCA 45X2; TUBO 35	11,97
924804524224	DN MANGUERA 1" 1/2; ROSCA 52X2; TUBO 42	19,37

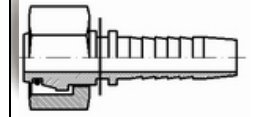

90°Metric Swivel Female with O'ring 24° Cone with Crimped Nut DKO Light serie		
Кодировка	Характеристики	€
924305120603	DN MANGUERA 3/16"; ROSCA 12X1,5; TUBO 6	5,74
924305120604	DN MANGUERA 1/4"; ROSCA 12X1,5; TUBO 6	4,38
924305140804	DN MANGUERA 1/4"; ROSCA 14X1,5; TUBO 8	2,34
924305161004	DN MANGUERA 1/4"; ROSCA 16X1,5; TUBO 10	2,72
924305161005	DN MANGUERA 5/16"; ROSCA 16X1,5; TUBO 10	2,75
924305161006	DN MANGUERA 3/8"; ROSCA 16X1,5; TUBO 10	5,27
924305181205	DN MANGUERA 5/16"; ROSCA 18X1,5; TUBO 12	3,29
924305181206	DN MANGUERA 3/8"; ROSCA 18X1,5; TUBO 12	2,46
924305221506	DN MANGUERA 1/2"; ROSCA 22X1,5; TUBO 15	5,16
924305221508	DN MANGUERA 1/2"; ROSCA 22X1,5; TUBO 15	3,78
924305261810	DN MANGUERA 5/8"; ROSCA 26X1,5; TUBO 18	5,46
924305302212	DN MANGUERA 3/4"; ROSCA 30X2; TUBO 22	8,16
924305362816	DN MANGUERA 1"; ROSCA 36X2; TUBO 28	14,35
924305453520	DN MANGUERA 1" 1/4; ROSCA 45X2; TUBO 35	26,66
924305524224	DN MANGUERA 1" 1/2; ROSCA 52X2; TUBO 42	42,26

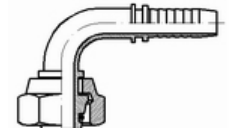

45°Metric Swivel Female with O'ring 24° Cone with Crimped Nut DKO

Light serie

Кодировка	Характеристики	€
924306120604	DN MANGUERA 1/4"; ROSCA 12X1,5; TUBO 6	4,44
924306140804	DN MANGUERA 1/4"; ROSCA 14X1,5; TUBO 8	2,34
924306161004	DN MANGUERA 1/4"; ROSCA 16X1,5; TUBO 10	2,63
924306161005	DN MANGUERA 5/16"; ROSCA 16X1,5; TUBO 10	3,00
924306161006	DN MANGUERA 3/8"; ROSCA 16X1,5; TUBO 10	5,87
924306181205	DN MANGUERA 5/16"; ROSCA 20X1,5; TUBO 12	4,50
924306181206	DN MANGUERA 3/8"; ROSCA 18X1,5; TUBO 12	3,21
924306221508	DN MANGUERA 1/2"; ROSCA 22X1,5; TUBO 15	4,24
924306261810	DN MANGUERA 5/8"; ROSCA 26X1,5; TUBO 18	6,30
924306302212	DN MANGUERA 3/4"; ROSCA 30X2; TUBO 22	8,70
924306362816	DN MANGUERA 1"; ROSCA 36X2; ROSCA 28	16,51
924306453520	DN MANGUERA 1" 1/4; ROSCA 45X2; TUBO 35	27,00
924306524224	DN MANGUERA 1" 1/2; ROSCA 52X2; TUBO 42	37,50

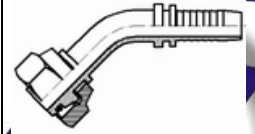

Metric Stud 24° Cone

Light serie

Кодировка	Характеристики	€
924203120603	DN MANGUERA 3/16"; ROSCA 12X1,5; TUBO 6	2,79
924203120604	DN MANGUERA 1/4"; ROSCA 12X1,5; TUBO 6	1,50
924203140804	DN MANGUERA 1/4"; ROSCA 14X1,5; TUBO 8	1,42
924203161004	DN MANGUERA 1/4"; ROSCA 16X1,5; TUBO 10	1,74
924203161005	DN MANGUERA 5/16"; ROSCA 16X1,5; TUBO 10	1,41
924203161006	DN MANGUERA 3/8"; ROSCA 16X1,5; TUBO 10	1,54
924203181204	DN MANGUERA 1/4"; ROSCA 18X1,5; TUBO 12	2,60
924203181205	DN MANGUERA 5/16"; ROSCA 18X1,5; TUBO 12	1,98
924203181206	DN MANGUERA 3/8"; ROSCA 18X1,5; TUBO 12	1,36
924203221408	DN MANGUERA 1/2"; ROSCA 22X1,5; TUBO 14	2,96
924203221506	DN MANGUERA 3/8"; ROSCA 22X1,5; TUBO 15	2,22
924203221508	DN MANGUERA 1/2"; ROSCA 22X1,5; TUBO 15	1,67
924203261808	DN MANGUERA 1/2"; ROSCA 26X1,5; TUBO 18	4,10
924203261810	DN MANGUERA 5/8"; ROSCA 26X1,5; TUBO 18	3,36
924203302212	DN MANGUERA 3/4"; ROSCA 30X2; TUBO 22	4,08
924203362816	DN MANGUERA 1"; ROSCA 36X2; TUBO 28	8,74
924203453520	DN MANGUERA 1" 1/4; ROSCA 45X2; TUBO 35	12,86
924203524224	DN MANGUERA 1" 1/2; ROSCA 52X2; TUBO 42	19,84

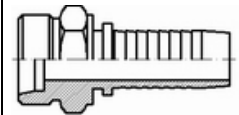

Banjo Metric(one only piece)

Кодировка	Характеристики	€
9241161003	DN MANGUERA 3/16"; ORIENTABLE M10X1	2,90
9241161004	DN MANGUERA 1/4"; ORIENTABLE M10X1	1,62
9241161204	DN MANGUERA 1/4"; ORIENTABLE M12X1.5	2,58
9241161404	DN MANGUERA 1/4"; ORIENTABLE M14X1.5	2,58
9241161405	DN MANGUERA 5/16"; ORIENTABLE M14X1.5	2,59
9241161406	DN MANGUERA 3/8"; ORIENTABLE M14X1.5	2,72
9241161605	DN MANGUERA 5/16"; ORIENTABLE M16X1.5	3,33
9241161606	DN MANGUERA 3/8"; ORIENTABLE M16X1.5	3,33
9241161806	DN MANGUERA 3/8"; ORIENTABLE M18X1.5	4,11
9241161808	DN MANGUERA 1/2"; ORIENTABLE M18X1.5	4,22
9241162006	DN MANGUERA 3/8"; ORIENTABLE M20X1.5	8,43
9241162208	DN MANGUERA 1/2"; ORIENTABLE M22X1.5	5,27
9241162210	DN MANGUERA 5/8"; ORIENTABLE M22X1.5	10,80
9241162610	DN MANGUERA 5/8"; ORIENTABLE M26X1.5	20,61
9241163012	DN MANGUERA 3/4"; ORIENTABLE M30X2	43,93



Metric Swivel Female 24°/60° Cone DKL

Кодировка	Характеристики	€
9244049511	DN MANGUERA 1/4"; ROSCA M14X1.5; TUBO 8L	1,29
9244049520	DN MANGUERA 1/4"; ROSCA M16X1.5; TUBO 10L	1,67
9244049523	DN MANGUERA 5/16"; ROSCA M16X1.5; TUBO 10L	1,37
9244049524	DN MANGUERA 3/8"; ROSCA M16X1.5; TUBO 10L	1,89
9244049525	DN MANGUERA 5/16"; ROSCA M18X1.5; TUBO 12L	1,76
9244049535	DN MANGUERA 3/8"; ROSCA M18X1.5; TUBO 12L	1,46
9244049552	DN MANGUERA 3/8"; ROSCA M22X1.5; TUBO 15L	2,66
9244049555	DN MANGUERA 1/2"; ROSCA M22X1.5; TUBO 15L	2,10
9244049571	DN MANGUERA 5/8"; ROSCA M26X1.5; TUBO 18L	3,73

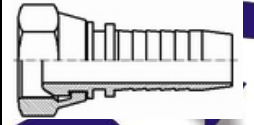

90°Metric Swivel Female 24°/60° Cone DKL

Кодировка	Характеристики	€
9244059511	DN MANGUERA 1/4"; ROSCA M14X1.5; TUBO 8L	2,57
9244059520	DN MANGUERA 1/4"; ROSCA M16X1.5; TUBO 10L	3,64
9244059523	DN MANGUERA 5/16"; ROSCA M16X1.5; TUBO 10L	3,21
9244059524	DN MANGUERA 3/8"; ROSCA M16X1.5; TUBO 10L	5,10
9244059525	DN MANGUERA 5/16"; ROSCA M18X1.5; TUBO 12L	4,76
9244059535	DN MANGUERA 3/8"; ROSCA M18X1.5; TUBO 12L	3,30
9244059552	DN MANGUERA 3/8"; ROSCA M22X1.5; TUBO 15L	6,56
9244059555	DN MANGUERA 1/2"; ROSCA M22X1.5; TUBO 15L	4,71
9244059571	DN MANGUERA 5/8"; ROSCA M26X1.5; TUBO 18L	10,20

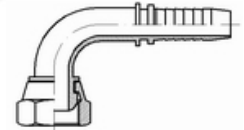

45°Metric Swivel Female 24°/60° Cone DKL

Кодировка	Характеристики	€
9244069511	DN MANGUERA 1/4"; ROSCA M14X1.5; TUBO 8L	2,91
9244069520	DN MANGUERA 1/4"; ROSCA M16X1.5; TUBO 10L	4,24
9244069523	DN MANGUERA 5/16"; ROSCA M16X1.5; TUBO 10L	3,73
9244069524	DN MANGUERA 3/8"; ROSCA M16X1.5; TUBO 10L	5,10
9244069525	DN MANGUERA 5/16"; ROSCA M18X1.5; TUBO 12L	4,76
9244069535	DN MANGUERA 3/8"; ROSCA M18X1.5; TUBO 12L	3,21
9244069552	DN MANGUERA 3/8"; ROSCA M22X1.5; TUBO 15L	7,03
9244069555	DN MANGUERA 1/2"; ROSCA M22X1.5; TUBO 15L	4,41
9244069571	DN MANGUERA 5/8"; ROSCA M26X1.5; TUBO 18L	11,61

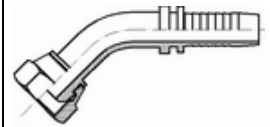

Standpipes for DIN 2353 Fittings

Кодировка	Характеристики	€
9241580602 L	DN MANGUERA 1/8"; TUBO 6	2,14
9241580603 L	DN MANGUERA 3/16"; TUBO 6	1,46
9241580803 L	DN MANGUERA 3/16"; TUBO 8	1,80
9241580804 L	DN MANGUERA 1/4"; TUBO 8	0,99
9241580604 L	DN MANGUERA 1/4"; TUBO 6	0,90
9241580805 L	DN MANGUERA 5/16"; TUBO 8	3,49
9241581005 L	DN MANGUERA 5/16"; TUBO 10	1,03
9241581006 L	DN MANGUERA 3/8"; TUBO 10	1,15
9241581206 L	DN MANGUERA 3/8"; TUBO 12	1,02
9241581506 L	DN MANGUERA 3/8"; TUBO 15	2,06
9241581208 L	DN MANGUERA 1/2"; TUBO 12	4,23
9241581508 L	DN MANGUERA 1/2"; TUBO 15	1,59
9241581808 L	DN MANGUERA 1/2"; TUBO 18	1,98
9241581810 L	DN MANGUERA 5/8"; TUBO 18	2,61
9241582212 L	DN MANGUERA 3/4"; TUBO 22	2,75
9241582816 L	DN MANGUERA 1"; TUBO 28	7,95
9241583520 L	DN MANGUERA 1"1/4; TUBO 35	11,40
9241584224 L	DN MANGUERA 1"1/2; TUBO 42	15,43
9241580804 S	DN MANGUERA 1/4"; TUBO 8	1,11
9241581004 S	DN MANGUERA 1/4"; TUBO 10	0,90
9241581204 S	DN MANGUERA 1/4"; TUBO 12	1,68
9241581205 S	DN MANGUERA 5/16"; TUBO 12	1,24
9241581406 S	DN MANGUERA 3/8"; TUBO 14	1,41
9241581408 S	DN MANGUERA 1/2"; TUBO 14	2,23
9241581608 S	DN MANGUERA 1/2"; TUBO 16	1,71
9241582010 S	DN MANGUERA 5/8"; TUBO 20	2,44
9241582012 S	DN MANGUERA 3/4"; TUBO 20	3,00
9241582512 S	DN MANGUERA 3/4"; TUBO 25	4,41
9241582516 S	DN MANGUERA 1"; TUBO 25	8,01
9241583016 S	DN MANGUERA 1"; TUBO 30	8,27
9241583820 S	DN MANGUERA 1"1/4; TUBO 38	11,19



90°Standpipes for DIN 2353 Fittings

Кодировка	Характеристики	€
9242580603 L	DN MANGUERA 3/16"; TUBO 6	3,92
9242580803 L	DN MANGUERA 3/16"; TUBO 8	4,24
9242580604 L	DN MANGUERA 1/4"; TUBO 6	2,87
9242580804 L	DN MANGUERA 1/4"; TUBO 8	3,13
9242581204 L	DN MANGUERA 1/4"; TUBO 12	4,20
9242581006 L	DN MANGUERA 3/8"; TUBO 10	3,47
9242581206 L	DN MANGUERA 3/8"; TUBO 12	3,43
9242581508 L	DN MANGUERA 1/2"; TUBO 15	5,36
9242581808 L	DN MANGUERA 1/2"; TUBO 18	4,93
9242581810 L	DN MANGUERA 5/8"; TUBO 18	8,74
9242582210 L	DN MANGUERA 5/8"; TUBO 22	10,63
9242582212 L	DN MANGUERA 3/4"; TUBO 22	8,01
9242582816 L	DN MANGUERA 1"; TUBO 28	21,13
9242583520 L	DN MANGUERA 1"1/4; TUBO 35	27,94
9242581004 S	DN MANGUERA 1/4"; TUBO 10	3,13
9242581205 S	DN MANGUERA 5/16"; TUBO 12	4,24
9242581406 S	DN MANGUERA 3/8"; TUBO 14	4,01
9242581408 S	DN MANGUERA 1/2"; TUBO 14	5,61
9242581608 S	DN MANGUERA 1/2"; TUBO 16	6,00
9242582012 S	DN MANGUERA 3/4"; TUBO 20	9,73
9242582512 S	DN MANGUERA 3/4"; TUBO 25	12,00
9242583016 S	DN MANGUERA 1"; TUBO 30	20,57
9242582010 S	DN MANGUERA 5/8"; TUBO 20	11,74

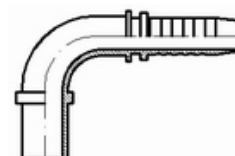

45°Standpipes for DIN 2353 Fittings		
Кодировка	Характеристики	€
9243580603 L	DN MANGUERA 3/16"; TUBO 6	3,92
9243580804 L	DN MANGUERA 1/4"; TUBO 8	3,81
9243581005 L	DN MANGUERA 5/16"; TUBO 10	4,32
9243581006 L	DN MANGUERA 3/8"; TUBO 10	4,11
9243581206 L	DN MANGUERA 3/8"; TUBO 12	4,04
9243581508 L	DN MANGUERA 1/2"; TUBO 15	6,55
9243581810 L	DN MANGUERA 5/8"; TUBO 18	9,03
9243582212 L	DN MANGUERA 3/4"; TUBO 22	10,86
9243582010 S	DN MANGUERA 5/8"; TUBO 20	11,30
9243581004 S	DN MANGUERA 1/4"; TUBO 10	3,30
9243581205 S	DN MANGUERA 5/16"; TUBO 12	4,44
9243581406 S	DN MANGUERA 3/8"; TUBO 14	8,82
9243581608 S	DN MANGUERA 1/2"; TUBO 16	6,93
9243582012 S	DN MANGUERA 3/4"; TUBO 20	11,30
9243582512 S	DN MANGUERA 3/4"; TUBO 25	20,01

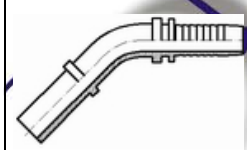

Metric Swivel Female with O'ring 24° Cone Heavy serie		
Кодировка	Характеристики	€
924804160803	DN MANGUERA 3/16"; ROSCA 16X1,5; TUBO 8	3,34
924804160804	DN MANGUERA 1/4"; ROSCA 16X1,5; TUBO 8	1,42
924804181004	DN MANGUERA 1/4"; ROSCA 18X1,5; TUBO 10	1,68
924804201205	DN MANGUERA 5/16"; ROSCA 20X1,5; TUBO 12	2,00
924804201206	DN MANGUERA 3/8"; ROSCA 20X1,5; TUBO 12	1,78
924804221406	DN MANGUERA 3/8"; ROSCA 22X1,5; TUBO 14	2,66
924804241608	DN MANGUERA 1/2"; ROSCA 24X1,5; TUBO 16	2,58
924804302010	DN MANGUERA 5/8"; ROSCA 30X2; TUBO 20	4,20
924804302012	DN MANGUERA 3/4"; ROSCA 30X2; TUBO 20	7,01
924804362512	DN MANGUERA 3/4"; ROSCA 36X2; TUBO 25	7,07
924804362516	DN MANGUERA 1"; ROSCA 36X2; TUBO 25	11,79
924804423016	DN MANGUERA 1"; ROSCA 42X2; TUBO 30	10,04
924804523820	DN MANGUERA 1" 1/4; ROSCA 52X2; TUBO 38	18,30

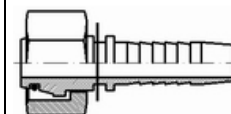

90°Metric Swivel Female with O'ring 24° Cone with Crimped Nut DKO Heavy serie		
Кодировка	Характеристики	€
924305160804	DN MANGUERA 1/4"; ROSCA 16X1,5; TUBO 8	2,95
924305181004	DN MANGUERA 1/4"; ROSCA 16X1,5; TUBO 10	3,30
924305201205	DN MANGUERA 5/16"; ROSCA 20X1,5; TUBO 12	3,80
924305201206	DN MANGUERA 3/8"; ROSCA 20X1,5; TUBO 12	3,19
924305221406	DN MANGUERA 3/8"; ROSCA 22X1,5; TUBO 14	4,98
924305241608	DN MANGUERA 1/2"; ROSCA 24X1,5; TUBO 16	4,58
924305302010	DN MANGUERA 5/8"; ROSCA 30X2; TUBO 20	8,25
924305302012	DN MANGUERA 3/4"; ROSCA 30X2; TUBO 20	13,35
924305362512	DN MANGUERA 3/4"; ROSCA 36X2; TUBO 25	14,31
924305362516	DN MANGUERA 1"; ROSCA 36X2; TUBO 25	24,26
924305423016	DN MANGUERA 1"; ROSCA 42X2; TUBO 30	21,51
924305523820	DN MANGUERA 1" 1/4; ROSCA 52X2; TUBO 38	40,80

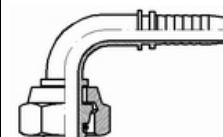

45°Metric Swivel Female with O'ring 24° Cone with Crimped Nut DKO Heavy serie		
Кодировка	Характеристики	€
924306160804	N MANGUERA 1/4"; ROSCA 16X1,5; TUBO 8	3,64
924306181004	DN MANGUERA 1/4"; ROSCA 18X1,5; TUBO 10	4,33
924306201205	DN MANGUERA 5/16"; ROSCA 20X1,5; TUBO 12	4,37
924306201206	DN MANGUERA 3/8"; ROSCA 20X1,5; TUBO 12	4,37
924306221406	DN MANGUERA 3/8"; ROSCA 22X1,5; TUBO 14	5,36
924306241608	DN MANGUERA 1/2"; ROSCA 24X1,5; TUBO 16	4,80
924306302010	DN MANGUERA 5/8"; ROSCA 30X2; TUBO 20	9,04
924306302012	DN MANGUERA 3/4"; ROSCA 30X2; TUBO 20	16,37
924306362512	DN MANGUERA 3/4"; ROSCA 36X2; TUBO 25	14,31
924306362516	DN MANGUERA 1"; ROSCA 36X2; TUBO 25	24,43
924306423016	DN MANGUERA 1"; ROSCA 42X2; TUBO 30	20,40
924306523820	DN MANGUERA 1" 1/4; ROSCA 52X2; TUBO 38	38,57

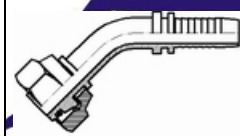

Metric Stud 24° Cone Heavy serie		
Кодировка	Характеристики	€
924203160804	DN MANGUERA 1/4"; ROSCA 16X1,5; TUBO 8	2,23
924203181004	DN MANGUERA 1/4"; ROSCA 18X1,5; TUBO 10	2,07
924203181005	DN MANGUERA 1/16"; ROSCA 18X1,5; TUBO 10	2,61
924203181006	DN MANGUERA 3/8"; ROSCA 18X1,5; TUBO 10	2,96
924203201205	DN MANGUERA 5/16"; ROSCA 20X1,5; TUBO 12	2,10
924203201206	DN MANGUERA 3/8"; ROSCA 20X1,5; TUBO 12	1,90
924203221406	DN MANGUERA 3/8"; ROSCA 22X1,5; TUBO 14	2,31
924203241608	DN MANGUERA 1/2"; ROSCA 24X1,5; TUBO 16	2,45
924203302010	DN MANGUERA 5/8"; ROSCA 30X2; TUBO 20	4,88
924203302012	DN MANGUERA 3/4"; ROSCA 30X2; TUBO 20	4,98
924203362512	DN MANGUERA 3/4"; ROSCA 36X2; TUBO 25	7,50
924203362516	DN MANGUERA 1"; ROSCA 36X2; TUBO 25	10,20
924203423016	DN MANGUERA 1"; ROSCA 42X2; TUBO 30	11,97
924203523820	DN MANGUERA 1" 1/4; ROSCA 52X2; TUBO 38	20,23



Фитинги метрические (Французская серия)

Metric Stud 24° Cone French Serie		
Кодировка	Характеристики	€
9245032013.204	DN MANGUERA 1/4"; ROSCA M20X1.5; TUBO 13.2	1,42
9245032013.205	DN MANGUERA 5/16"; ROSCA M20X1.5; TUBO 13.2	1,20
9245032013.206	DN MANGUERA 3/8"; ROSCA M20X1.5; TUBO 13.2	1,20
9245032416.705	DN MANGUERA 5/16"; ROSCA M24X1.5; TUBO 16.7	1,68
9245032416.706	DN MANGUERA 3/8"; ROSCA M24X1.5; TUBO 16.7	1,50
9245032416.708	DN MANGUERA 1/2"; ROSCA M24X1.5; TUBO 16.7	1,50 €
9245033021210	DN MANGUERA 5/8"; ROSCA M30X1.5; TUBO 21.2	21,08
9245033021212	DN MANGUERA 3/4"; ROSCA M30X1.5; TUBO 21.2	7,63
9245033325012	DN MANGUERA 3/4"; ROSCA M33X1.5; TUBO 25	8,08
9245033626712	DN MANGUERA 3/4"; ROSCA M36X1.5; TUBO 26.7	23,99
9245034533516	DN MANGUERA 1"; ROSCA M45X1.5; TUBO 33.5	28,80



Metric Swivel Female 24° Cone French Serie

Кодировка	Характеристики	€
9244043021210	DN MANGUERA 5/8"; ROSCA M33X1.5; TUBO 21.2	10,07
9244043626712	DN MANGUERA 3/4"; ROSCA M36X1.5; TUBO 26.7	26,01
9244044533516	DN MANGUERA 1"; ROSCA M45X1; TUBO 33.5	38,91
9245042013.204	DN MANGUERA 1/4"; ROSCA M20X1.5; TUBO 13.2	1,70
9245042013.205	DN MANGUERA 5/16"; ROSCA M20X1.5; TUBO 13.2	1,65
9245042013.206	DN MANGUERA 3/8"; ROSCA M20X1.5; TUBO 13.2	1,75
9245042416.705	DN MANGUERA 5/16"; ROSCA M24X1.5; TUBO 16.7	2,47
9245042416.706	DN MANGUERA 3/8"; ROSCA M24X1.5; TUBO 16.7	2,45
9245042416.708	DN MANGUERA 1/2"; ROSCA M24X1.5; TUBO 16.7	2,45

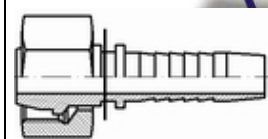

90°Metric Swivel Female 24° Cone French Serie

Кодировка	Характеристики	€
9245052013205	DN MANGUERA 5/16"; ROSCA M20X1.5; TUBO 13.2	5,95
9245052013206	DN MANGUERA 3/8"; ROSCA M20X1.5; TUBO 13.2	7,79
9245052416708	DN MANGUERA 1/2"; ROSCA M24X1.5; TUBO 16.7	11,53
9245052673612	DN MANGUERA 3/4"; ROSCA M36X1.5; TUBO 26.7	33,30
9245053021210	DN MANGUERA 5/8"; ROSCA M30X1.5; TUBO 21.2	18,33

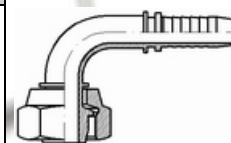

Metric Stud for Agricultural Valve

Кодировка	Характеристики	€
9245051804	DN MANGUERA 1/4"; ROSCA M18X1.5	2,44
9245051805	DN MANGUERA 5/16"; ROSCA M18X1.5	2,44
9245051806	DN MANGUERA 3/8"; ROSCA M18X1.5	2,44



Фитинги метрические (Японская серия)

Metric Swivel Female Komatsu Japanese Serie 60° Cone

Кодировка	Характеристики	€
9258049625	DN MANGUERA 1/4"; ROSCA M14X1.5	6,56
9258049635	DN MANGUERA 3/8"; ROSCA M18X1.5	5,10
9258049655	DN MANGUERA 1/2"; ROSCA M22X1.5	6,75
9258049665	DN MANGUERA 5/8"; ROSCA M24X1.5	10,03
9258049684	DN MANGUERA 3/4"; ROSCA M30X1.5	17,97
9258049685	DN MANGUERA 1"; ROSCA M33X1.5	23,16



Фланцевые соединения S.A.E. 3000/6000 PSI

3000 PSI Straight Flange		
Кодировка	Характеристики	
9241821612	DN MANGUERA 3/4"; BRIDA Ø 44.5	13,20
9241821208	DN MANGUERA 1/2"; BRIDA Ø 38.1	12,13
9241821210	DN MANGUERA 5/8"; BRIDA Ø 38.1	16,54
9241821212	DN MANGUERA 3/4"; BRIDA Ø 38.1	9,73
9241821616	DN MANGUERA 1"; BRIDA Ø 44.5	13,46
9241822016	DN MANGUERA 1"; BRIDA Ø 50.8	18,73
9241822020	DN MANGUERA 1"1/4; BRIDA Ø 50.8	18,81
9241822420	DN MANGUERA 1"1/4; BRIDA Ø 60.3	26,44
9241822424	DN MANGUERA 1"1/2; BRIDA Ø 60.3	27,21
9241823224	DN MANGUERA 1"1/2; BRIDA Ø 71.4	44,83
9241823232	DN MANGUERA 2"; BRIDA Ø 71.4	42,26



3000 PSI 90° Flange		
Кодировка	Характеристики	€
9241830808	DN MANGUERA 1/2"; BRIDA Ø 30.2	10,97
9241831208	DN MANGUERA 1/2"; BRIDA Ø 38.1	16,54
9241831210	DN MANGUERA 5/8"; BRIDA Ø 38.1	19,84
9241831212	DN MANGUERA 3/4"; BRIDA Ø 38.1	13,50
9241831612	DN MANGUERA 3/4"; BRIDA Ø 44.5	16,16
9241831616	DN MANGUERA 1"; BRIDA Ø 44.5	19,20
9241832016	DN MANGUERA 1"; BRIDA Ø 50.8	28,46
9241832020	DN MANGUERA 1"1/4; BRIDA Ø 50.8	30,77
9241832420	DN MANGUERA 1"1/4; BRIDA Ø 60.3	44,83
9241832424	DN MANGUERA 1"1/2; BRIDA Ø 60.3	45,94
9241833224	DN MANGUERA 1"1/2; BRIDA Ø 71.4	83,01
9241833232	DN MANGUERA 2"; BRIDA Ø 71.4	95,02

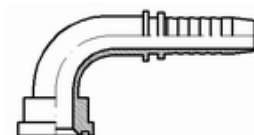

3000 PSI 45° Flange		
Кодировка	Характеристики	€
9241840808	DN MANGUERA 1/2"; BRIDA Ø 30.2	12,51
9241841208	DN MANGUERA 1/2"; BRIDA Ø 38.1	17,27
9241841210	DN MANGUERA 5/8"; BRIDA Ø 38.1	26,44
9241841212	DN MANGUERA 3/4"; BRIDA Ø 38.1	13,24
9241841612	DN MANGUERA 3/4"; BRIDA Ø 44.5	16,37
9241841616	DN MANGUERA 1"; BRIDA Ø 44.5	17,27
9241842016	DN MANGUERA 1"; BRIDA Ø 50.8	23,87
9241842020	DN MANGUERA 1"1/4; BRIDA Ø 50.8	25,93
9241842420	DN MANGUERA 1"1/4; BRIDA Ø 60.3	40,63
9241842424	DN MANGUERA 1"1/2; BRIDA Ø 60.3	42,64
9241843224	DN MANGUERA 1"1/2; BRIDA Ø 71.4	79,03
9241843232	DN MANGUERA 2"; BRIDA Ø 71.4	95,02

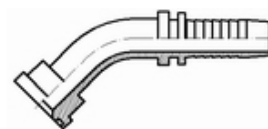

6000 PSI Straight Flange		
Кодировка	Характеристики	€
9242822016	DN MANGUERA 1"; BRIDA Ø 54	21,69
9242820808	DN MANGUERA 1/2"; BRIDA Ø 31.8	10,37
9242821208	DN MANGUERA 1/2"; BRIDA Ø 41.3	15,09
9242821210	DN MANGUERA 5/8"; BRIDA Ø 41.3	17,66
9242821212	DN MANGUERA 3/4"; BRIDA Ø 41.3	12,69
9242821612	DN MANGUERA 3/4"; BRIDA Ø 47.6	15,81
9242821616	DN MANGUERA 1"; BRIDA Ø 47.6	16,80
9242822020	DN MANGUERA 1"1/4; BRIDA Ø 54	20,96
9242822420	DN MANGUERA 1"1/4; BRIDA Ø 63.5	31,59
9242822424	DN MANGUERA 1"1/2; BRIDA Ø 63.5	35,66
9242823224	DN MANGUERA 1"1/2; BRIDA Ø 79.4	67,97
9242823232	DN MANGUERA 2"; BRIDA Ø 79.4	54,56



6000 PSI 90° Flange		
Кодировка	Характеристики	€
9242830808	DN MANGUERA 1/2"; BRIDA Ø 31.8	11,91
9242831208	DN MANGUERA 1/2"; BRIDA Ø 41.3	19,11
9242831210	DN MANGUERA 5/8"; BRIDA Ø 41.3	21,77
9242831212	DN MANGUERA 3/4"; BRIDA Ø 41.3	14,91
9242831612	DN MANGUERA 3/4"; BRIDA Ø 47.6	19,84
9242831616	DN MANGUERA 1"; BRIDA Ø 47.6	21,60
9242832016	DN MANGUERA 1"; BRIDA Ø 54	32,19
9242832020	DN MANGUERA 1"1/4; BRIDA Ø 54	32,70
9242832420	DN MANGUERA 1"1/4; BRIDA Ø 63.5	58,07
9242832424	DN MANGUERA 1"1/2; BRIDA Ø 63.5	62,10
9242833224	DN MANGUERA 1"1/2; BRIDA Ø 79.4	114,64

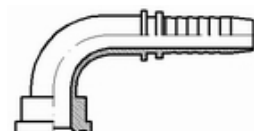

6000 PSI 45° Flange		
Кодировка	Характеристики	€
9242840808	DN MANGUERA 1/2"; BRIDA Ø 31.8	13,24
9242841208	DN MANGUERA 1/2"; BRIDA Ø 41.3	19,11
9242841210	DN MANGUERA 5/8"; BRIDA Ø 41.3	28,67
9242841212	DN MANGUERA 3/4"; BRIDA Ø 41.3	14,91
9242841612	DN MANGUERA 3/4"; BRIDA Ø 47.6	20,06
9242841616	DN MANGUERA 1"; BRIDA Ø 47.6	19,46
9242842016	DN MANGUERA 1"; BRIDA Ø 54	30,51
9242842020	DN MANGUERA 1"1/4; BRIDA Ø 54	33,13
9242842420	DN MANGUERA 1"1/4; BRIDA Ø 63.5	53,44
9242842424	DN MANGUERA 1"1/2; BRIDA Ø 63.5	60,39
9242843224	DN MANGUERA 1"1/2; BRIDA Ø 79.4	114,26
9242843232	DN MANGUERA 2"; BRIDA Ø 79.4	130,56

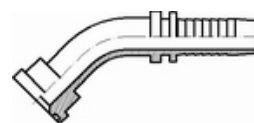

O'ring for 3000 PSI Flange		
Кодировка	Характеристики	€
955.56X3.53	DIAMETRO INTERIOR 55.56; ESPESOR (mm) 3.53	0,46
923.39X3.53	DIAMETRO INTERIOR 23.39; ESPESOR (mm) 3.53	0,19
931.34X3.53	DIAMETRO INTERIOR 31.34; ESPESOR (mm) 3.53	0,24
936.09X3.53	DIAMETRO INTERIOR 36.09; ESPESOR (mm) 3.53	0,29
946.04X3.53	DIAMETRO INTERIOR 46.04; ESPESOR (mm) 3.53	0,42



Фланцевые соединения CATERPILLAR

9000 PSI Caterpillar Straight Flange		
Кодировка	Характеристики	€
9442821212	DN MANGUERA 3/4"; BRIDA Ø 41.3	16,03
9442821612	DN MANGUERA 3/4"; BRIDA Ø 47.6	20,79
9442821616	DN MANGUERA 1"; BRIDA Ø 47.6	20,91
9442822016	DN MANGUERA 1"; BRIDA Ø 54	31,16
9442822020	DN MANGUERA 1"1/4; BRIDA Ø 54	31,16
9442822424	DN MANGUERA 1"1/2; BRIDA Ø 63.5	45,81



9000 PSI Caterpillar 90° Flange		
Кодировка	Характеристики	€
9442831212	DN MANGUERA 3/4"; BRIDA Ø 41.3	23,27
9442831612	DN MANGUERA 3/4"; BRIDA Ø 47.6	35,57
9442831616	DN MANGUERA 1"; BRIDA Ø 47.6	30,04
9442832016	DN MANGUERA 1"; BRIDA Ø 54	41,10
9442832020	DN MANGUERA 1"1/4; BRIDA Ø 54	47,40
9442832424	DN MANGUERA 1"1/2; BRIDA Ø 63.5	68,96

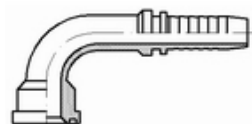

9000 PSI Caterpillar 45° Flange		
Кодировка	Характеристики	€
9442841212	DN MANGUERA 3/4"; BRIDA Ø 41.3	23,27
9442841612	DN MANGUERA 3/4"; BRIDA Ø 47.6	35,57
9442841616	DN MANGUERA 1"; BRIDA Ø 47.6	30,64
9442842016	DN MANGUERA 1"; BRIDA Ø 54	46,11
9442842020	DN MANGUERA 1"1/4; BRIDA Ø 54	46,93
9442842424	DN MANGUERA 1"1/2; BRIDA Ø 63.5	65,91



Хомуты SAE

SAE Split Flanges 3000/6000 PSI		
Кодировка	Характеристики	€
9AFS602	TUBO 3/4"; SERIE 6000 PSI	6,20
9AFS301	TUBO 1/2"; SERIE 3000 PSI	4,10
9AFS302	TUBO 3/4"; SERIE 3000 PSI	4,67
9AFS303	TUBO 1"; SERIE 3000 PSI	5,57
9AFS304	TUBO 1"1/4; SERIE 3000 PSI	6,33
9AFS305	TUBO 1"1/2; SERIE 3000 PSI	8,93
9AFS306	TUBO 2"; SERIE 3000 PSI	11,70
9AFS307	TUBO 2"1/2; SERIE 3000 PSI	25,01
9AFS308	TUBO 3"; SERIE 3000 PSI	35,25
9AFS309	TUBO 3"1/2; SERIE 3000 PSI	54,73
9AFS310	TUBO 4"; SERIE 3000 PSI	69,11
9AFS311	TUBO 5"; SERIE 3000 PSI	86,74
9AFS601	TUBO 1/2"; SERIE 6000 PSI	5,50
9AFS603	TUBO 1"; SERIE 6000 PSI	9,65
9AFS604	TUBO 1"1/4; SERIE 6000 PSI	15,49
9AFS605	TUBO 1"1/2; SERIE 6000 PSI	21,37
9AFS606	TUBO 2"; SERIE 6000 PSI	34,93

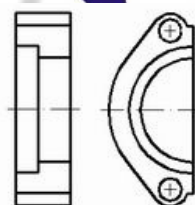

SAE Flanges 3000/6000 PSI		
Кодировка	Характеристики	€
9AFSI301	TUBO 1/2"; SERIE 3000 PSI	4,10
9AFSI302	TUBO 3/4"; SERIE 3000 PSI	4,67
9AFSI303	TUBO 1"; SERIE 3000 PSI	5,57
9AFSI304	TUBO 1"1/4; SERIE 3000 PSI	6,33
9AFSI305	TUBO 1"1/2; SERIE 3000 PSI	8,93
9AFSI306	TUBO 2"; SERIE 3000 PSI	11,70
9AFSI307	TUBO 2"1/2; SERIE 3000 PSI	25,01
9AFSI308	TUBO 3"; SERIE 3000 PSI	35,25
9AFSI309	UBO 3"1/2; SERIE 3000 PSI	54,73
9AFSI310	TUBO 4"; SERIE 3000 PSI	69,11
9AFSI311	TUBO 5"; SERIE 3000 PSI	86,74
9AFSI601	UBO 1/2"; SERIE 6000 PSI	5,50
9AFSI602	TUBO 3/4"; SERIE 6000 PSI	6,20
9AFSI603	TUBO 1"; SERIE 6000 PSI	9,65
9AFSI604	TUBO 1"1/4; SERIE 6000 PSI	15,49
9AFSI605	TUBO 1"1/2; SERIE 6000 PSI	21,37
9AFSI606	TUBO 2"; SERIE 6000 PSI	34,93

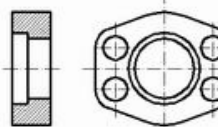

Фланец POCLAIN

Poclain Male Flange Standpipe		
Кодировка	Характеристики	€
9448010808	DN MANGUERA 1/2"; BRIDA 1/2"	6,56
9448011010	DN MANGUERA 5/8"; BRIDA 5/8"	7,83
9448011212	DN MANGUERA 3/4"; BRIDA 3/4"	9,94
9448011616	DN MANGUERA 1"; BRIDA 1"	14,16
9448012020	DN MANGUERA 1"1/4; BRIDA 1"1/4	18,12



Poclain Female Flange Standpipe		
Кодировка	Характеристики	€
9448020808	DN MANGUERA 1/2"; BRIDA 1/2"	6,56
9448021010	DN MANGUERA 5/8"; BRIDA 5/8"	7,83
9448021212	DN MANGUERA 3/4"; BRIDA 3/4"	9,94
9448021616	DN MANGUERA 1"; BRIDA 1"	14,16
9448022020	DN MANGUERA 1"1/4; BRIDA 1"1/4	18,12

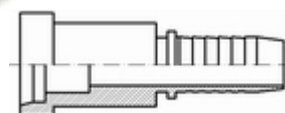

90°Poclain Female Flange Standpipe		
Кодировка	Характеристики	€
9448030808	DN MANGUERA 1/2"; BRIDA 1/2"	15,70
9448031010	DN MANGUERA 5/8"; BRIDA 5/8"	18,72
9448031212	DN MANGUERA 3/4"; BRIDA 3/4"	23,76
9448031616	DN MANGUERA 1"; BRIDA 1"	33,84
9448032020	DN MANGUERA 1"1/4; BRIDA 1"1/4	43,34

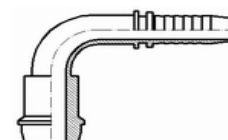

Хомут POCLAIN

Male Poclain Flange 4 holes		
Кодировка	Характеристики	€
9448050808	TUBO 1/2"	11,71
9448051010	TUBO 5/8"	12,22
9448051212	TUBO 3/4"	14,24
9448051616	TUBO 1"	17,34
9448052020	TUBO 1" ¼	26,32

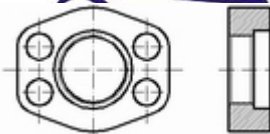

Female Poclain Flange 4 holes		
Кодировка	Характеристики	€
9448060808	TUBO 1/2"	11,71
9448061010	TUBO 5/8"	12,22
9448061212	TUBO 3/4"	14,24
9448061616	TUBO 1"	17,34
9448062020	TUBO 1" 1/4	26,32

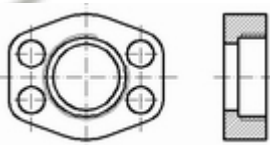

Male Poclain Flange 2 holes		
Кодировка	Характеристики	€
9448070808	BRIDA 1/2"	11,71
9448071010	BRIDA 5/8"	12,22
9448071212	BRIDA 3/4"	14,24
9448071616	BRIDA 1"	17,34
9448072020	BRIDA 1"1/4	26,32

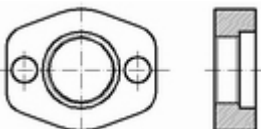

Female Poclain Flange 2 holes		
Кодировка	Характеристики	€
9448080808	BRIDA 1/2"	13,85
9448081010	BRIDA 5/8"	14,04
9448081212	BRIDA 3/4"	24,02
9448081616	BRIDA 1"	17,74
9448082020	BRIDA 1"1/4	19,32

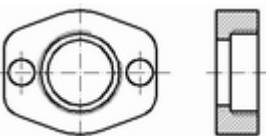

Фитинги ORFS

ORFS Caterpillar Straight Swivel Female Flat Seat		
Кодировка	Характеристики	€
9449000404	DN MANGUERA 1/4"; ROSCA 9/16" 18h UNF	2,06
9449000604	DN MANGUERA 1/4"; ROSCA 11/16" 16h UNF	2,95
9449000605	DN MANGUERA 5/16"; ROSCA 11/16" 16h UNF	2,79
9449000606	DN MANGUERA 3/8"; ROSCA 11/16" 16h UNF	2,58
9449000806	DN MANGUERA 3/8"; ROSCA 13/16" 16h UNF	3,60
9449000808	DN MANGUERA 1/2"; ROSCA 13/16" 16h UNF	3,12
9449001008	DN MANGUERA 1/2"; ROSCA 1" 14h UNF	4,63
9449001010	DN MANGUERA 5/8"; ROSCA 1" 14h UNF	4,27
9449001208	DN MANGUERA 1/2"; ROSCA 1" 3/16 12h UNF	9,86
9449001212	DN MANGUERA 3/4"; ROSCA 1"3/16 12h UNF	6,99
9449001612	DN MANGUERA 3/4"; ROSCA 1" 7/16 12h UNF	11,96
9449001616	DN MANGUERA 1"; ROSCA 1"7/16 12h UNF	10,07
9449002020	DN MANGUERA 1"1/4; ROSCA 1"11/16 12h UNF	17,96
9449002424	DN MANGUERA 1"1/2; ROSCA 2" 12h UNF	32,44



90°ORFS Caterpillar Swivel Female Flat Seat		
Кодировка	Характеристики	€
9449070404	DN MANGUERA 1/4"; ROSCA 9/16" 18h UNF	3,23
9449070605	DN MANGUERA 5/16"; ROSCA 11/16" 16h UNF	5,19
9449070606	DN MANGUERA 1/4"; ROSCA 11/16" 16h UNF	3,86
9449070806	DN MANGUERA 3/8"; ROSCA 11/16" 16h UNF	5,91
9449070808	DN MANGUERA 3/8"; ROSCA 13/16" 16h UNF	5,10
9449071010	DN MANGUERA 5/8"; ROSCA 1" 14h UNF	11,49
9449071208	DN MANGUERA 1/2"; ROSCA 1 3/16-12h UNF	20,10
9449071212	DN MANGUERA 3/4"; ROSCA 1"3/16 12h UNF	12,39
9449071612	DN MANGUERA 3/4"; ROSCA 1" 7/16 12h UNF	23,27
9449071616	DN MANGUERA 1"; ROSCA 1"7/16 12h UNF	22,48
9449072020	DN MANGUERA 1"1/4; ROSCA 1"11/16 12h UNF	38,36
9449072424	DN MANGUERA 1"1/2; ROSCA 2" 12h UNF	85,42

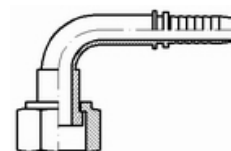

45°ORFS Caterpillar Swivel Female Flat Seat		
Кодировка	Характеристики	€
9449080404	DN MANGUERA 1/4"; ROSCA 9/16" 18h UNF	3,60
9449080606	DN MANGUERA 3/8"; ROSCA 11/16" 16h UNF	3,86
9449080806	DN MANGUERA 3/8"; ROSCA 13/16" 16h UNF	5,91
9449080808	DN MANGUERA 1/2"; ROSCA 13/16" 16h UNF	5,10
9449081008	DN MANGUERA 1/2"; ROSCA 1" - 14h UNF	10,07
9449081010	DN MANGUERA 5/8"; ROSCA 1" 14h UNF	11,49
9449081212	DN MANGUERA 3/4"; ROSCA 1"3/16 12h UNF	12,64
9449081616	DN MANGUERA 1"; ROSCA 1"7/16 12h UNF	21,26
9449082020	DN MANGUERA 1"1/4; ROSCA 1"11/16 12h UNF	38,36
9449082424	DN MANGUERA 1"1/2; ROSCA 2" 12h UNF	85,42

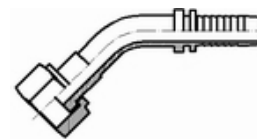

ORFS Male Flat SEAT O'ring		
Кодировка	Характеристики	€
9449120404	DN MANGUERA 1/4"; ROSCA 9/16" 18h UNF	5,14
9449120604	DN MANGUERA 1/4"; ROSCA 11/16" 16h UNF	8,49
9449120605	DN MANGUERA 5/16"; ROSCA 11/16" 16h UNF	8,49
9449120606	DN MANGUERA 3/8"; ROSCA 11/16" 16h UNF	5,19
9449120808	DN MANGUERA 1/2"; ROSCA 13/16" 16h UNF	5,36
9449121010	DN MANGUERA 5/8"; ROSCA 1" 14h UNF	9,30
9449121212	DN MANGUERA 3/4"; ROSCA 1"3/16 12h UNF	12,30
9449121616	DN MANGUERA 1"; ROSCA 1"7/16 12h UNF	15,51
9449122020	DN MANGUERA 1"1/4; ROSCA 1"11/16-12h UNF	16,80

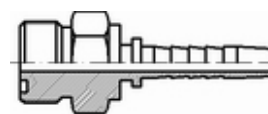

Фитинги для стиральных машин

Special brass Ende-Hydrowasher

Кодировка	Характеристики	€
9230500500	DN MANGUERA 5/16; ROSCA M22X1.5	5,35
9230500400	DN MANGUERA 1/4"; ROSCA M22X1.5	5,35
9230500600	DN MANGUERA 3/8"; ROSCA M22X1.5	5,35

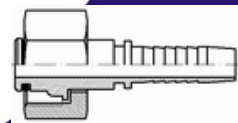

Male Terminal Steel Hydro-Washing Mashines

Кодировка	Характеристики	€
9230400400	DN MANGUERA 1/4"	4,81



Handel with grey rubber

Кодировка	Характеристики	€
9230610400	DN MANGUERA 1/4"	2,57
9230610500	DN MANGUERA 5/16"	2,57
9230610600	DN MANGUERA 3/8"	2,66



Handel with black rubber

Кодировка	Характеристики	€
9230600400	DN MANGUERA 1/4"	2,27
9230600500	DN MANGUERA 5/16"	2,27
9230600600	DN MANGUERA 3/8"	2,44



Handel with blue rubber

Кодировка	Характеристики	€
9230620500	DN MANGUERA 5/16"	2,57
9230620600	DN MANGUERA 3/8"	2,66



Swivel Female Terminal Steel Hydro-Wash

Кодировка	Характеристики	€
9K230700600		2,15
9230700400	ROSCA M22X1.5; TUBO 1/4	4,63
9230700500	ROSCA M22X1.5; TUBO 5/16	3,64
9230700600	ROSCA M22X1.5; TUBO 3/8	3,86



Фитинги разные

Double Crimp Standpipe		
Кодировка	Характеристики	€
9243000404	DN MANGUERA 1/4"	3,39
9243000505	DN MANGUERA 5/16"	3,57
9243000606	DN MANGUERA 3/8"	3,80
9243000808	DN MANGUERA 1/2"	5,58
9243001212	DN MANGUERA 3/4"	9,66
9243001616	DN MANGUERA 1"	19,71



Male Stecko Connection		
Кодировка	Характеристики	€
9241900404	DN MANGUERA 1/4"; TUBO STECKO 1/4"	2,74
9241900606	DN MANGUERA 3/8"; TUBO STECKO 3/8"	3,00
9241900808	DN MANGUERA 1/2"; TUBO STECKO 1/2"	3,51
9241901212	DN MANGUERA 3/4"; TUBO STECKO 3/4"	9,81



ПРИМЕЧАНИЯ.

“Manguera” - Рукав
 “Rosca” - Резьба
 “Brida” - Хомут

INVERETCOM S.L.

WTCB, Muelle de Barcelona, Edificio Norte,
6^a planta
BARCELONA - SPAIN

TEL +34 93 412 63 91 FAX +34 93 412 16 70
CIF B63534127

www.inveret.com
info@inveret.com

Информацию по фитингам,
которые не фигурируют в нашем
каталоге, Вы можете получить
связавшись с нами.

